



Fold along dotted line

Place
Stamp
Here

ATTN: SERVICE DEPARTMENT

Fold along dotted line



M2201010

WEIBANG®

M2201010

Yangzhou Weibang Garden Machine Company Limited
Hanjiang Industrial Park, Yangzhou City, Jiangsu
Province 225127, P. R. China

FLAIL MOWER

Model: WBG T6813
WBG T8013



Operator's manual
(Original instruction)



DO NOT operate this equipment until you have read and understood all the enclosed Operator's Manual.
READ ALL the sections in this manual **PRIOR** to attempting to service, maintain or operate this equipment. !

Symbols Explanation of Warning Signs

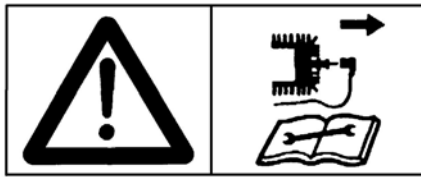

Before any cleaning, maintenance, and repair work switch off the engine and pull spark plug connector.

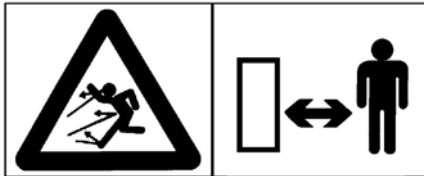

With engine running, keep at a safe distance. Dirt and stones may get airborne during sweeping. People and animals must keep out of this area.



When working with the machine, wear individual protective ear plugs.



Beware of sharp blade(s). Keep hands and feet out of openings while machine is running.



Wear protective gloves.



Risk of contact with hot surface.



Wear solid shoes.

Warning – Danger

Important information



Choke



Wheel drive



Fuel



Rotor drive



Oil



Slow



Engine Start



Fast



Engine Stop



The engine exhaust from this production contains chemicals known to cause cancer, birth defects, or other reproductive harm. Engine produces carbon monoxide which is an odorless deadly poison. Do not operate in an enclosed area.

Read all the sections in this manual prior to attempting to service, maintain or operate this equipment.

WEIBANG FLAIL MOWER

Operator's Manual

Contents

1.PRE-OPERATION NOTE.....	01
2.SAFETY PRECAUTIONS.....	03
3.ASSEMBLY.....	13
4.FEATURES AND CONTROLS.....	14
5.TRANSPORTING THE SWEEPER.....	15
6.PRE-OPERATION PROCEDURES.....	15
7.OPERATION PROCEDURES.....	17
8.SERVICE AND ADJUTMENT.....	20
9.MAINTENANCE.....	22
10.STORAGE.....	28
11.TROUBLESHOOTING.....	30

Following security identity is to remind you always pay attention to safety during operation:

Danger:

Show immediate serious results of injury or death.

Warning:

Show unsafe actions or conditions may cause serious injury, death or damage to major equipment.

Caution:

Show unsafe action or conditions may cause injury or property damage.

Any modification unauthorized by manufacturer is prohibited. These modifications will change the performance and reliability of this machine or cause safety hazards to operators, and lead to the failure of warranty.

Pre-Operation Note

Thank you for your purchase of WEIBANG professional flail mower. This mower has been designed and manufactured to our highest quality demands for durability and performance.

WEIBANG Garden Machine Company Limited is committed to offering durable products and quality after-market service. The WEIBANG flail mower is warranted to be free from manufacturer's defects in material and workmanship for a period of one (1) year from the date of purchase (except used for commercial purpose or hire and rental applications). This warranty will be void if the machine has not been operated and maintained in the manner prescribed in this Operator's Manual. Any machine malfunctions, and/or warranty claims that arise from the misinterpretation or the misunderstanding of the instructions and cautions discussed in this booklet will not be eligible for warranty protection.

In order for the flail mower to perform at its optimum capabilities, the operator must read this manual thoroughly before using this unit. This Operator's Manual contains important product operation procedures, safety precautions, maintenance and troubleshooting tips as well as other advisories. Please keep this manual nearby when operating the lift as a reference should any questions arise.

WBGT6813/WBGT8013 flail mower is a professional grassland machine with high efficiency suited for application in amenity areas clearance. The mower is constructed for normal use in agricultural, forestry and landscaping to cut and /or mulch grass or similar plants or scrub and woody vegetation. The machine should not be used for any other purpose than that stated above. Any other type of operation is considered undue. Due use includes compliance with manufacturer's instructions on operation, maintenance and repair.

The inappropriate use of any machine can cause serious damage and/or bodily harm to the environment and operator. The manufacturer is not liable for any damages resulting from undue use, for which the risk lies with the user alone.

It is imperative that the operator of this equipment be responsible for the operational environment of the mower. Please read, understand and follow all instructions that are provided in this manual. Please be prepared and well-informed for all specific requirements precautions and work hazards that may and/or do exist at the jobsite.

Powered by a 6.6kW engine, the flail mower is a powerful unit. A rotor with free-swinging

Pre-Operation Note cont'd ...

"Y" type blades equipped is very durable and high grass cleaning easily. Failure to maintain the mower in a proper manner will lead to decreased productivity of the tool and hazards to the operator and bystanders. Inspect you jobsite for any debris such as rocks, wiring, string or and other items that can become hazardous during work. Identify and mark all fixed objects to be avoided during work, such as sprinkler heads, water valves, buried cables, or clothes line anchors etc. **Do not use the machine if it has been modified or improperly maintained.** Any unauthorized changes to the mower render manufacturer liability null and void.

All jobsites are different. Please ensure that when using this flail mower, all local bylaws and codes are followed. All operators and mechanics of this machine should be trained in general machine use and safety.

Every care and effort has been made to ascertain the accuracy and completeness of procedures described in this document to ensure your enjoyment and satisfaction. If you have any questions or concerns, please contact the local WEIBANG's exclusive national distributor.

SPECIFICATIONS

MODEL	WBG T6813	WBG T8013
ENGINE MAKE/MODEL	BRILLIANT GT1300PE, 392 cc single cylinder petrol engine /Air cool	
ENGINE POWER	6.6 kW @ 3600 rpm,	
STARTER	Recoil starter	
FUEL TANK	6 Liters	
TRANSMISSION	WEIBANG CVT	
DRIVE	2WD	
SPEED	Step less variable- forward gear from 0 to 5.5 km/h - reverse gear from 0 to 3.5 km/h	
DRIVE WHEELS	16" TRACTOR wheels 4.00-8 (solid and puncture-proof)	
FRONT WHEELS	8" castor (solid and puncture-proof)	
PARKING BRAKE	Auto park Brake	
HANDLEBAR	Quickly adjustable both vertically and laterally	
<i>Operability on Slopes: (with engine oil level at "max" = upper level mark)</i>	Continuous operation possible up to 12° inclination (20 %)	
Y-SHAPED BLADES OF ROTOR	38pcs	46pcs
CUTTING HEIGHT	from 0 to 90 mm, quick adjustment via rocker arm	
CUTTING WIDTH	680 mm	800 mm
ROTOR SPEED	2200 rpm	
OVERALL SIZE LxWxH	1800 mm x 860 mm x1050 mm	
WEIGHT	243 kg	268 kg
<i>Noise level</i>	Noise at operator's ear Lpa: 87.2dB(A), K=3dB(A) Noise power Lwa: 98.15dB(A), K=3dB(A)	
<i>Vibration acceleration value(left /right):</i>	on handlebar grip in accordance with 2002/44/EC $a_{hw} = 3.785 / 4.148m/s^2$; K=1.5m/s ² .	
Blade type:	GT68WC02000/01	

These specifications are provided as a reference, these are familiarized with the flail mower We reserve the right to make technical changes and other without advance notification. It is possible that some details in this manual do not coincide completely with your machine.

Pre-Operation Note cont'd ...

Please complete:

Machine Type: _____

ID/Machine SERIAL No.: _____

Engine Type: _____

Engine No.: _____

Date of Purchase: _____

THE MODEL AND SERIAL NUMBERS WILL BE FOUND ON A DECAL ATTACHED TO THE REAR OF THE MACHINE HOUSING.

YOU SHOULD RECORD BOTH SERIAL NUMBER AND DATE OF PURCHASE AND KEEP IN A SAFE PLACE FOR FUTURE REFERENCE.

We recommend that you write down the serial number and purchase date in your user manual, so that you will always have it at hand.

Please state these data when ordering spare parts to avoid wrong deliveries.

Should you experience any problem you cannot easily remedy, please contact the nearest authorized service center/department. We have competent, well-trained technicians and the proper tools to service or repair this mower.

Please read and retain this manual. The instructions will enable you to assemble and maintain your mower properly. Always observe the "SAFETY REGULATIONS"

Only use original WEIBANG spare parts!

These specifications are provided as a reference, these are familiarized with the mower. We reserve the right to make technical changes and other without advance notification. It is possible that some details in this manual do not coincide completely with your machine.

! Residual risks

Even when the power tool is used as safety rules prescribed it is not possible to eliminate all residual risk factors. The following hazards may arise in connection with the power tool's construction and design:

1. Damage to lungs if an effective dust mask is not worn.
2. Damage to hearing if effective hearing protection is not worn.
3. Damages to health resulting from vibration emission if the power tool is being used over longer period of time or not adequately managed and properly maintained.

Safety Precautions

WARNING: This appliance is not intended for use by persons (including children) with reduced physical, sensory or mental capabilities, or lack of experience and knowledge, unless they have been given supervision or instruction concerning use of the appliance by a person responsible for their safety. Children should be supervised to ensure that they do not play with the appliance.

Before starting the engine, read the operating instructions and note:

Warning

This symbol marks all paragraphs which affect your safety. Pass all safety instructions to other users and operators.

Safety Precautions cont'd ...

I. General Operation

- Users need adequate training.
- Before starting to use this machine, read, understand and follow all instructions that are provided in this manual. Be thoroughly familiar with the controls and the proper use of the machine before starting operations.



WARNING: Do not put your hands or feet near or under rotating parts. Keep clear of the discharge opening at all times.

- This machine may only be operated by responsible persons, who are familiar with the operating instructions. Never allow children or people unfamiliar with these instructions to use the lawnmower. Local regulations can restrict the age of the operator.
- To prevent injury, be sure that there are no persons in the immediate area where you are mowing. If any person enters this area, stop the machine by releasing the drive control bar. Never mow while people, especially children, or pets are nearby.
- Keep in mind that the operator or user is responsible for accidents or hazards occurring to other people or their property.



CAUTION: Do not operate the mower when barefoot or while wearing open sandals. Always robust footwear when mowing.

- While mowing, always wear substantial footwear and long trousers. Do not operate the equipment when barefoot or wearing open sandals.
- Always look down and behind you, before and while moving backwards. Use extreme caution when reversing or pulling the mower towards you.
- Before operating the mower, make sure that all protective screens and other protective devices are properly installed. Never operate the mower with defective guards, or without safety devices, in place.
- Observe the instructions of the manufacturer, for proper operation and installation of accessories. Only those accessories that have been approved by the manufacturer may be used.
- Make sure that the blade(s) of the mower is (are) not rotating, before crossing gravel drives, walkways or roads.
- Mowing should only be done during daylight or under good artificial lighting.
- Do not operate the machine while being tired, ill or under the influence of alcohol or drugs.
- Use slip-resistant shoes as well as suitable clothing. Never operate the mower in wet grass, where feasible. Always be sure of your footing. Keep a firm hold on the handle and walk.
- Operator's clothes should fit tight. Avoid wearing loose fitting clothes. Wear solid shoes.

- Before starting the engine (motor), disengage all blade and self-propelling mechanism or drive clutch on mowers so equipped.

- If the mower should start to vibrate abnormally, stop the engine (motor) and check immediately for the cause. Vibration is generally a warning of trouble.

- Keep hands and feet away from the enclosure.

- Worn parts should be referred to our repair shop to be replaced. If necessary, contact the service specified address.

- Before using the machine, inspect the machine by visual to determine whether the cutting, fastening bolts and the entire mower deck worn or damaged. To avoid an imbalance may be, replace worn out or damaged cutting attachment bolts sets.

- Secure the unit during transport to prevent loss of fuel, damage or injury.

- Warning! Do not use the unit in the event of thunderstorm.

- Follow the maintenance schedule in this manual. Poor maintenance may lead to hazard risk of fire, unit damage or personal injury.

- Only use original spare parts from manufacture. Unapproved parts may lead to unit damage and unforeseeable risk.

- This appliance is not intended for use by persons (including children) with reduced physical, sensory or mental capabilities, or lack of experience and knowledge, unless they have been given supervision or instruction concerning use of the appliance by a person responsible for their safety.



WARNING! This machine produces an electromagnetic field during operation. This field may under some circumstances interfere with active or passive medical implants. To reduce the risk of serious or fatal injury, we recommend persons with medical implants to consult their physician and the medical implant manufacturer before operating this machine.



Do not use this machine under lightning.

II. SLOPE OPERATION

- Slopes are a major factor related to slip and fall accidents, which can result in severe injury. All slopes require extra caution. If you feel uneasy on a slope, do not mow it.

DO:

- Mow across the face of slopes: never up and down. Exercise extreme caution when changing direction on slopes.
- Watch for holes, ruts, or bumps. Tall grass can hide obstacles.

Safety Precautions cont'd ...

- Keep all movement on the slopes slow and gradual.
- Keep safety devices (guards, shields, and switches) in place and working.

DO NOT:

- Do not trim near drop-offs, ditches or embankments. The operator could lose footing or balance.
- Do not trim excessively steep slopes over 20% (of approximately 1.6 feet for every 10 feet).
- Do not mow on wet grass. Reduced footing could cause slipping.
- Do not mow on wet grass. Reduced footing could cause slipping.
- Do not make sudden changes in speed or direction. Avoid sudden turns.
- Avoid starting or stopping flail mower on a slope.

III. CHILDREN

Tragic accidents can occur if the operator is not alert to the presence of children. Children are often attracted to the machine and the mowing activity. Never assume that children will remain where you last saw them.

- Keep children out of the trimming area and under the watchful care of another responsible adult.
- Be alert and turn machine off if children enter the area.
- Before and while walking backwards, look behind and down for small children.
- Never allow children to operate the machine.
- Use extra care when approaching blind corners, shrubs, trees, or other objects that may obscure vision.
- The flail mower is a professional unit, never allow teenagers of 18 years or younger to operate the mower.

IV. GENERAL INSTRUCTIONS FOR WORKING WITH YOUR FLAIL MOWER

- **WARNING**-petrol is highly flammable. Use extra care in handling gasoline and other fuels. They are flammable and vapors are explosive.
 - Store fuel in containers specially designed for this purpose; Use only an approved fuel container.
 - Refuel outdoors only and do not smoke while refueling; Never refuel the machine indoors.
 - Never store the machine or fuel container near an open flame, such as a water heater
 - Add fuel before starting the engine. Never remove the cap of the fuel tank or add petrol while the engine is running or when the engine is hot; Allow the engine to cool before refuelling.
 - If petrol is spilled, do not attempt to start the engine but move the machine away from the area of spillage and avoid creating any source of ignition until petrol vapors have dissipated.
 - Replace all fuel tanks and container caps securely;
 - Do not smoke in the neighbourhood of the mower.
- Replace faulty silencers
- Clean up any oil or fuel spills.

- Do not start the engine when standing in front of the discharge chute.
- Do not put hands or feet near or under rotating parts. Keep clear of the discharge opening at all times.
- Do not operate the engine in a confined space where dangerous carbon monoxide fumes can collect; Walk never run.
- Always be sure of your footing on slopes.
- Do not change the engine governor settings or over-speed the engine;
- Never make adjustments or repairs with the engine (motor) running. Disconnect the sparkplug wire, and keep the wire away from the plug to prevent accidental starting.
- Check regularly that nuts and bolts, especially blade attachment bolts, are fastened tightly and keep the equipment in a good condition.
- Never disable or tamper with safety systems or features. Check all starting interlocks and operator presence controls regularly and ensure they are properly functioning .
- Make sure that grass, leaves or other debris does not collect in the mower; check regularly and remove such residues to blocking.
- Stop and inspect your flail mower if you strike any object. Repair, if necessary, before restarting.
- Never attempt to make wheel height adjustments while the engine (motor) is running.
- Mower blades are sharp and can cause injuries. Wrap the blade(s) or wear gloves when handling them, and use extra caution during blade maintenance.
- Be especially careful in case you reverse the mower or going to use the machine.
- Stop the blade(s) if the flail mower has to be tilted for transportation when crossing surfaces other than grass, and when transporting the flail mower to and from the area to be mowed.
- Start the engine or switch on the motor carefully according to instructions and with feet well away from the blades.
- Do not tilt the mower when starting the engine or switching on the motor, except if the mower has to be tilted for starting. In this case, do not tilt it more than absolutely necessary and lift only the part which is away from the operator.
- Never pick up or carry the mower while the engine is running.
- Stop the engine and disconnect the spark plug wire.
 - Before clearing blockages or unclogging chute.
 - before checking, cleaning or working on the mower.
 - after striking a foreign object. Inspect the mower for damage and make repairs before re-starting and operating the mower;
- if flail mower starts to vibrate abnormally (check immediately).

Safety Precautions cont'd ...

- Stop the engine:
 - whenever you leave the flail mower.
 - before re-fuelling.
- Reduce the throttle setting during engine shut down and, if the engine is provided with a shut-off valve, turn the fuel off at the conclusion of mowing;
- Allow the engine to cool before storing in any enclosure.
- Never store the equipment with petrol in the tank inside a building where fumes can reach an open flame or spark. To reduce the fire hazard, keep the engine, silencer, battery compartment and petrol storage area free of grass, leaves, or excessive grease.
- If the fuel tank has to be drained, this should be done outdoors.



WARNING: Engine exhaust gases and some of its constituents, as well as certain other vehicle components contain or emit chemicals, which are known to cause cancer, possible birth defects or harm to the reproductive organs.

⚠ CAUTION: The above use and safety instructions must be strictly adhered to. The manufacturer assumes no liability for any damage caused by improper operation, improper use, misuse, unauthorized repairs or alterations performed.

CUSTOMER RESPONSIBILITIES

- Read and observe the safety regulations contained in this manual. This manual gives instructions on the correct assembly and safe use of your machine. It is important that you read these instructions carefully.
- Follow a regular schedule for maintaining, caring for and using your mower.
- Follow the instructions in the "Customer responsibilities" and "Storage" sections of this owner's manual.
- Remember that the operator is responsible for accidents with other persons or their property.
- **The flail mower is a HEAVY machine. The net weight is 243 kgs. It is recommended extremely using a crane to lift the unit.**

Operation and Safety Devices

Before You Start the Engine

- Ensure the operator is familiar with the devices and operating elements and their functions.
- Above all, learn how to turn the engine off quickly and safely in an emergency.
- Ensure that all protective devices are mounted and positioned to provide protection.

Starting the Engine

- Do not start engine in closed rooms. The carbon monoxide contained in the exhaust fume is extremely toxic when inhaled.
- Before you start the engine set all operating elements to neutral or idling position.
- For starting the engine, do not step in front of the flail mower and the implement.



Operation

When operating the mower, follow these guidelines for operator's personal safety:

- a. Always wear proper safety clothing and equipment for the job. These can and should include eye and ear protection, gloves, dust mask and any other items that are appropriate for the job and jobsite requirements.
- b. Never wear any jewelry, neck ties, or other loose or hanging items that can be caught on any part of the machine.
- c. Tie back or remove any loose hair, clothing and any other potential hazards and obstructions.
- d. Keep all hands, loose clothing, hair, jewelry and all other personal parts and belongings away from moving parts of the machine.
- e. Avoid coming in contact with the muffler and other engine parts after the engine is started and the time immediately after the machine is turned off. Machine and engine temperatures may exceed 150 °F or 66°C . Machine must be allowed to cool before touching it or attempting to perform any maintenance!

Safety Precautions cont'd ...

For the safety of others and that of the operator, observe the following precautions:

- a. Keep observers and bystanders away from the flail mower and its immediate working environment while the machine is in use.
- b. Stop operations or if anyone or anything (i.e.: humans, animals, debris etc.) approaches from the front or the sides while the machine is in operation.
- c. Stop work and turn off the flail mower if it hits any debris that jams the machine or causes it to labor un-necessarily. Inspect the machine and surrounding environment for any possible causes and have it repaired.
- d. If the machine is jammed, stop the engine and remove the sparkplug wire before attempting to clear any jams in the unit. Clean the brushes or the implement with an appropriate tool.
- e. DO NOT, under any circumstances, operate machine if any of the following conditions are applicable:
 - i. Any impairment (i.e.: medical conditions, medicinal side-effects, alcohol, drugs etc.) of the operator.
 - ii. The operator has not read or understood the operator's manual for this machine.
 - iii. The operator does not clearly understand the operations of the machine.
 - iv. The machine is in need of repair
 - v. The operator is inappropriately attired to operate the machine.
- f. Never leave the operator's position at the handlebars while flail mower is at work.
- g. Never adjust the operating handles during work – danger!
- h. During operation the operator must keep at a distance as defined by the handle-bars, especially when turning the machine.
- i. If steering causes problems, immediately bring the flail mower to a halt and turn it off. Have the malfunction removed without delay.
- j. To prevent the flail mower from sliding on slopes, make sure it is secured by another person using a bar or a rope. This person must be located at a higher position than the vehicle and at a safe distance from the attachment at work.
- k. If possible, always work horizontally on the slope.

End of Operation

- Never leave the flail mower unattended with the engine running.
- Before you leave the flail mower, turn off the engine.
- Secure flail mower against unauthorized use - remove spark plug connector.

SAVE THESE INSTRUCTIONS!!!

Working Area and Danger Zone

- The user is liable to third parties working within the flail mower's working range.
- Staying in the danger zone is not permitted.
- Check the immediate surroundings of the flail mower before you start it. Watch out for children and animals.
- Careful! Dirt and stones may get air-borne during mowing. People and animals must keep out of this area. Watch out for vehicles, window panes and other objects to avoid damage.
- Before you start work, clear the area from any foreign object. During operation, always watch out for further objects and remove them in time.
- For operation in enclosed areas, ensure that a safety distance is kept to enclosures to prevent damage to tools.

Safety Precautions cont'd ...

Maintenance and Cleaning

- Never carry out any maintenance or cleaning with the engine running.
- Before you work on the engine, always remove spark plug connector (petrol engine only).
- Check regularly and, if necessary, replace all guards and tools subject to wear and tear.
- Keep flail mower and implement clean to avoid risk of fire.
- Check nuts and bolts regularly for tight fit and re-tighten, if necessary.
- After maintenance and cleaning, ensure that you re-install all safety devices and guards and adjust them properly.
- Only use original WEIBANG spare parts. All other commercial spare parts must correspond to quality and technical requirements specified by WEIBANG.

Storage

- It is not allowed to store the flail mower in rooms with open heating.
- Never park the flail mower in closed rooms with fuel left in tank. Fuel vapours are hazardous.

Engine, Fuel, and Oil

- Never let the engine run in closed rooms. Extreme danger of intoxication!
- For the same reason, also replace damaged exhaust parts immediately.
- Caution with hot engine parts!
- The exhaust and other engine parts become very hot, if the engine runs and immediately after turning off. Hold for sufficient distance from hot surfaces and keep children away from the running engine.
- Be careful when dealing with fuel. Great danger of fire! Never refill fuel close to open fire, inflammable sparks or hot engine parts. Do not refill fuel in closed rooms. Do not smoke when refilling!
- Refill only with the engine switched off and cooled down.
- Do not spill any fuel, use a proper filling device.
- In case of fuel spillage, pull the flail mower away from the spillage before you start the engine.
- Make sure fuel is of specified quality.
- Store fuel in approved cans only.
- For safety reasons the petrol tank and fuel cap should be replaced regularly.
- Store anti-corrosive agents and stabilizing liquids out of reach of children. If sickness and vomiting occur, see a doctor. If fuel has contacted eyes, rinse them thoroughly, avoid inhaling of vapours.
- Read and observe enclosed instructions.
- Before you dispose of opened and seemingly empty pressurized tins (e.g. of assist-starting liquids) make sure they are completely empty. Empty them in ventilated places safe from spark formation or flames. If necessary, dispose of tins in hazardous waste deposits.
- Be careful when draining hot oil, danger of burns.
- Make sure oil is of specified quality. Storage is in approved cans only.
- Dispose of oil, greases, and filters separately and properly.

Safety Precautions cont'd ...

Tyres

- The flail mower is equipped with solid and puncture-proof maintenance free tyres.
- When working on tyres, make sure flail mower is parked properly and secured against rolling off.
- Any repairs are to be carried out by trained mechanics only and with the appropriate tools.

Electrical System

WARNING! This machine produces an electromagnetic field during operation. This field may under some circumstances interfere with active or passive medical implants. To reduce the risk of serious or fatal injury, we recommend persons with medical implants to consult their physician and the medical implant manufacturer before operating this machine.

Persons have pacemaker must not touch live parts of ignition system when the engine is running.

The above use and safety instructions must be strictly adhered to. The manufacturer assumes no liability for any damage caused by improper operation, improper use, misuse, unauthorized repairs or alterations performed.

WARNING: Engine exhaust gases and some of its constituents, as well as certain other vehicle components contain or emit chemicals, which are known to cause cancer, possible birth defects or harm to the reproductive organs.

Should you experience any problem you cannot easily remedy, please contact the nearest authorized service center/department. We have competent, well-trained technicians and the proper tools to service or repair this flail mower.

Please read and retain this manual. The instructions will enable you to assemble and maintain your flail mower properly. Always observe the SAFETY REGULATIONS

CUSTOMER RESPONSIBILITIES

- Read and observe the safety regulations contained in this manual.
- Follow a regular schedule for maintaining, caring for and using your mower.
- Follow the instructions in the "Customer responsibilities" and "Storage" sections of this owner's manual.
- Remember that the operator is responsible for accidents with other persons or their property.

Residual risks

Even when the power tool is used as prescribed it is not possible to eliminate all residual risk factors. The following hazards may arise in connection with the power tool's construction and design:

1. Damage to lungs if an effective dust mask is not worn.
2. Damage to hearing if effective hearing protection is not worn.
3. Damages to health resulting from vibration emission if the power tool is being used over longer period of time or not adequately managed and properly maintained.

WARNING

-petrol is highly flammable. Use extra care in handling gasoline and other fuels. They are flammable and vapors are explosive.

- Store fuel in containers specially designed for this purpose; Use only an approved fuel container.

Safety Precautions cont'd ...

- Refuel outdoors only and do not smoke while refueling; Never refuel the machine indoors.
- Never store the machine or fuel container near an open flame, such as a water heater
- Add fuel before starting the engine. Never remove the cap of the fuel tank or add petrol while the engine is running or when the engine is hot; Allow the engine to cool before refueling.
- If petrol is spilled, do not attempt to start the engine but move the machine away from the area of spillage and avoid creating any source of ignition until petrol vapors have dissipated.
- Replace all fuel tanks and container caps securely;
- Replace faulty silencers
- Clean up any oil or fuel spills.
- Do not put hands or feet near or under rotating parts. Keep clear of the discharge opening at all times.
- Do not operate the engine in a confined space where dangerous carbon monoxide fumes can collect;
- Walk and never run.
- Always be sure of your footing on slopes.
- Do not change the engine governor settings or over-speed the engine;
- Never make adjustments or repairs with the engine (motor) running. Disconnect the sparkplug wire, and keep the wire away from the plug to prevent accidental starting.
- Check regularly that nuts and bolts, especially blade attachment bolts, are fastened tightly and keep the equipment in a good condition.
- Never tamper with safety devices. Check their proper operation regularly.
- Make sure that grass, leaves or other debris does not collect in the rake; check regularly and remove such residues to blocking.
- Stop and inspect your rake if you strike any object. Repair, if necessary, before restarting.
- Never attempt to make wheel height adjustment while the engine (motor) is running.
- Start the engine or switch on the motor carefully according to instructions
- Never pick up or carry a flail mower while the engine is running.
- Stop the engine and disconnect the spark plug wire.
 - Before clearing blockages or brush roller.
 - Before checking, cleaning or working on the machine.
 - If machine starts to vibrate abnormally (check immediately).
- Stop the engine:
 - Whenever you leave the machine.
 - Before re-fuelling.
- Reduce the throttle setting during engine shut down and, if the engine is provided with a shut-off valve, turn the fuel off at the conclusion of mowing.
- Allow the engine to cool down before storing in any enclosure.
- Never store the equipment with petrol in the tank inside a building where fumes can reach an open flame or spark. To reduce the fire hazard, keep the engine, silencer, battery compartment and petrol storage area free of grass, leaves, or excessive grease.
- If the fuel tank has to be drained, this should be done outdoors.

Safety Precautions cont'd ...

GUIDE TO PARTS BREAKDOWN

Regular maintenance and parts replacement are important steps to extending the life of your equipment and enjoying its optimum performance. When performing or conducting any maintenance or repairs, always check that your working surroundings are safe and well-ventilated and that the technician is familiar and comfortable with all aspects of the machine and required procedures.

This guide aims to serve as a representational guide to the flail mower. Any other uses or application beyond the scope of this document are strictly prohibited. While every attempt has been made to maintain its accuracy, We reserve the right to update and modify the equipment without prior notification. Prior to undertaking to perform any maintenance or repair procedures, please Contact Our Technical Support Hotline for clarification and to acquire appropriate parts.

To order spare parts, please provide the following information:

1. Machine Make
2. Model Number
3. Machine Serial Number
4. Quantity Required of Each Part
5. Part Numbers
6. Part Descriptions.

All parts are guaranteed by a thirty (30) day warranty against any manufacturer's defects in workmanship and material. Consult the Operator's Manual for further details on our Warranty Policy.

CONTENTS LIST

Prior to setting up the WEIBANG WBGT6813 flail mower, check that the following items are enclosed:

Item	Quantity	Check if enclosed
WEIBANG Flail mower	1	___Yes ___No
WEIBANG Handle bar with clutch cable	1	___Yes ___No
WEIBANG Flail mower Operator's manual	1	___Yes ___No
Engine Operator's manual	1	___Yes ___No

If any of these items are missing, please contact local dealer and ask for the Service Department at once.

DO NOT ATTEMPT ASSEMBLY OR OPERATION WITHOUT ANY OF THESE LISTED PARTS

INFORMATION ON SAFETY DECALS

Below are the decals available for re-ordering to facilitate maintenance. All decals are available for replacement except that with the serial number of the unit for each number serves as a unique identifier for warranty and support purposes.

If you have any questions, please do not hesitate to contact your local weibang authorized dealer for further assistance.



Engine: Qty Required=1
PART No. L0106040Z

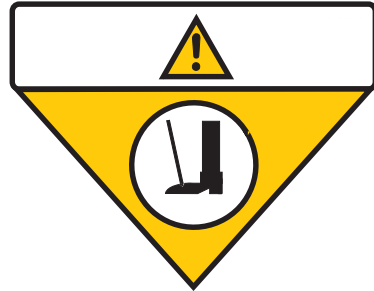

Danger: Qty Required=1
PART No. L0203000Z



Engine: Qty Required=1
PART No. Z61LP150



Service: Qty Required=2
PART No. L0106080Z

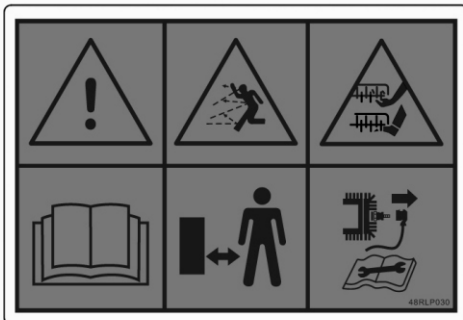

Warning: Qty Required=1
PART No. 48RLP030



Service: Qty Required=1
PART No. BCLP01330



Logo: Qty Required=1
PART No. L0401050

Assembly

Carefully read these instructions and this manual in its entirety, before you attempt to operate your new flail mower.

IMPORTANT: THIS FLAIL MOWER IS DELIVERED WITHOUT OIL OR PETROL IN THE ENGINE.

Your new flail mower has been pre-assembled at the factory, with the exception of those parts left unassembled for shipping purposes. All parts such as nuts, washers, bolts, etc necessary to complete the assembly have been attached on the machine. To assure safe and proper operation of your mower all parts and hardware you assemble must be tightened securely. Use the correct tools needed to assure proper tightening.



I UNPACKING INSTRUCTIONS

WARNING

To prevent personal injury or property damage, do not attempt to start the engine until all assembly steps are complete and you have read and understand the safety controls and operating instructions in this manual.

INTRODUCTION

Please carefully follow these assembly steps to properly prepare your machine for use. We recommend that you read this Section in its entirety before beginning assembly.

NOTE: All references to left, right, front and rear of the machine are determined by standing behind the handlebars and facing the direction of forward travel.

INSPECTION AFTER DELIVERY

When unpacking the machine, inspect for shipping damage or missing parts, if you find any damage, or if parts are missing, notify the local dealer who sold you the machine.

TOOLS/MATERIALS NEEDED:

Active Wrench / Motor Oil / Tire Gauge

UNPACKING STEPS

- Cut plastic banding. To open the box, remove top plywood panel firstly,
- Remove the handle bar with control levers.
- Remove all around wall panel.
- Remove the angle iron securing machine to wood pallet.
- Move the machine from the wood pallet.
- Check the box thoroughly and remove additional loose parts included with flail mower.
- Remove all packing materials.
- The flail mower is a HEAVY machine. The net weight is over 243kgs. DO NOT ATTEMPT TO MANUALLY LIFT ALONE!

It is recommended extremely using a crane to lift the unit.

NEVER ATTEMPT TO LIFT THE MACHINE WITH PERSON!!

Features And Controls

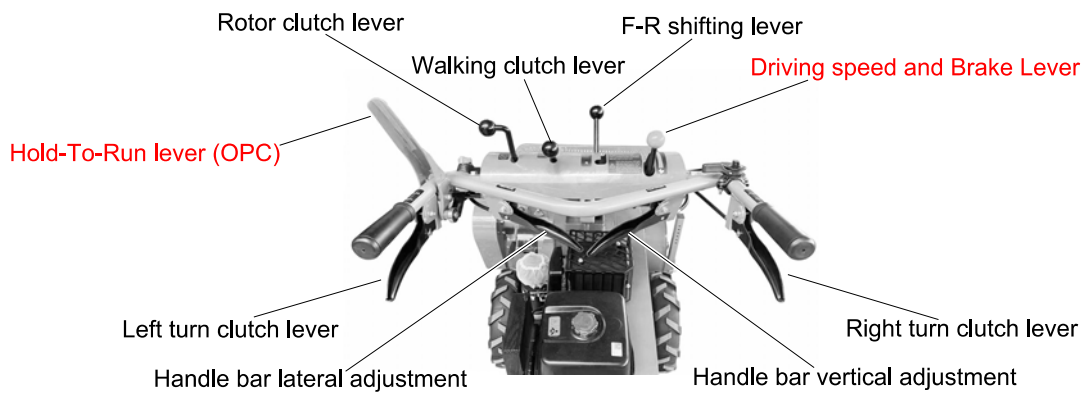
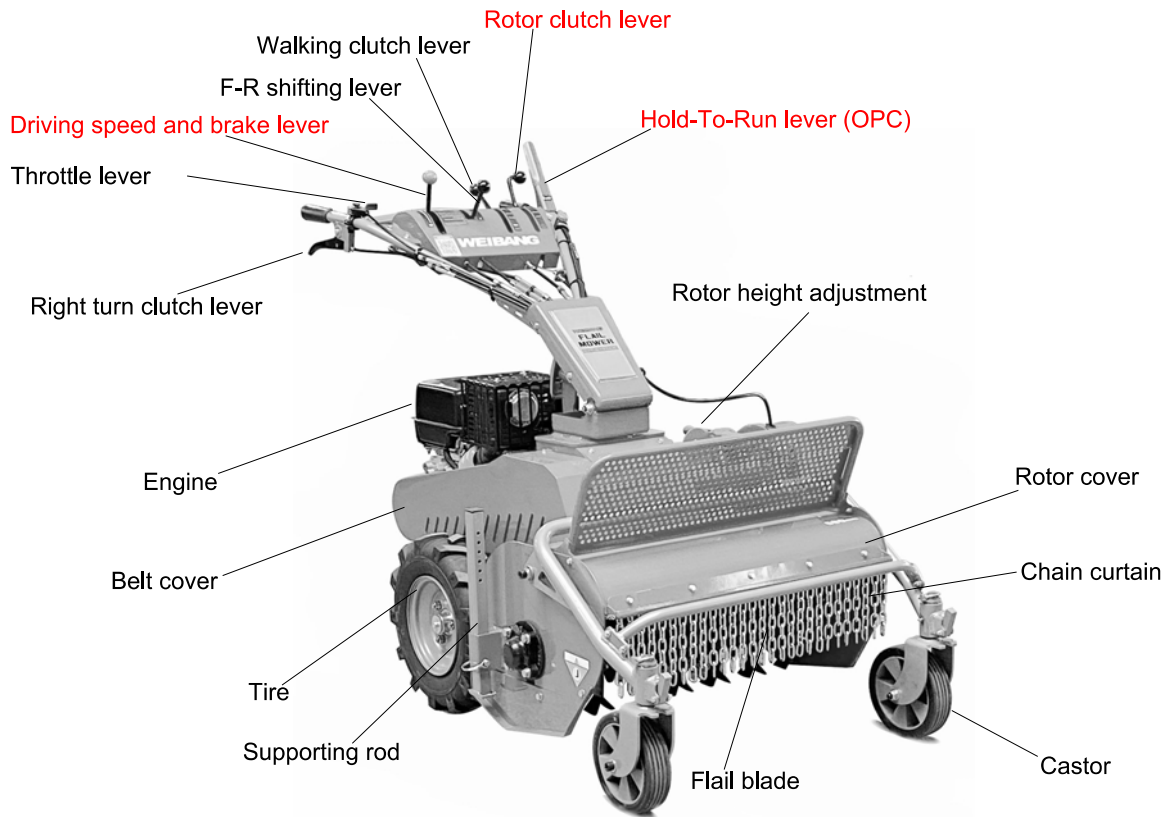

Transporting The Flail Mower

CAUTION: Do not transport or move machine while the engine or machine is running. Stop the engine and remove the sparkplug wire, and make sure that all moving parts have come to a complete stop. Prevent fuel spillage, gasoline is flammable and vapors are explosive.

- The flail mower is a HEAVY machine. The net weight is over 243kgs. It is recommended extremely using a crane to lift the unit.

If there is no crane for lifting, make sure that six people lifting the machine are capable of lifting at least 100 lbs/45.36kgs individually!!

- Working with partners, lift the unit to the transportation vehicle. ALWAYS use safe lifting techniques to avoid back or muscle injury! Consult your local health and safety organization for tips and best practices for moving heavy machinery.

- Use a heavy-duty trailer or truck to transport the machine. Block wheels and securely fasten the machine to the trailer or truck with straps, chains, cable, or ropes. Be sure that the trailer or truck has all necessary lighting and marking as required by law.

- Secure a trailer with a safety chain.

It is extremely recommended to use a heavy-duty trailer or truck to transport the machine for long distance.

Pre-Operation Procedures

Engine

The four-stroke petrol engine runs on commercial petrol (refer to fuel recommendations). During the first 20 operating hours (break-in period) do not operate the engine at maximum speed.

Even after the break-in period never operate the engine at higher speed than is necessary for the work in hand.

NOTE: High engine speed is harmful to any engine and considerably affects its longevity.

This applies especially for no load operation. Any over speed (have the engine roar) can result in immediate damage.

Cooling System

The **engine** is **fan-cooled**. Therefore keep the grille on the recoil starter and the cooling fins on the cylinder clean and free from sucked-in plant trash.

Idling Speed

Always ensure that idling-speed is adjusted correctly. At low speeds and with the speed control lever set to idle, the engine is supposed to run smoothly and without run-out.

Air Filter

The air filter cleans the air as it is in-ducted. A clogged filter reduces engine output.

Ignition System

The engine is equipped with a maintenance-free, contactless electronic ignition system. We recommend to have necessary check-ups done by an expert only.

Pre-Operation Procedures

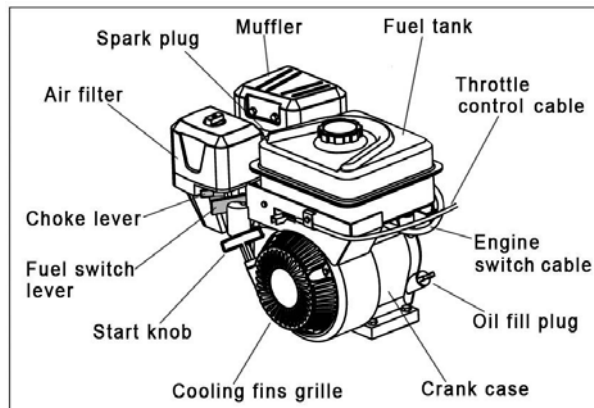

Commissioning the Machine

Please note that durability and operational safety of the engine depend to a large extent on its breaking-in. Always allow a cold engine to warm up for some minutes and never run it at full throttle at the beginning. Make sure the air filter is serviced regularly and to use clean fuel.

Please note:

For the first 20 hours of operation (break-in period) do not use the engine at full power.

Note: For reasons of transport, the engine is not filled with engine oil! Before you operate the engine the first time, fill in engine oil!

For this purpose, park the machine in such a way that the engine is in a horizontal position. For oil filling quantity and quality refer to "Specifications".

Check the oil level after filling.

Each time you take up operation

Check the engine oil level:

- Remove the oil fill plug.
- Clean the oil dip-stick with a clean rag, insert it again but do not screw it in.
- Remove the dip-stick and read the oil level. If necessary, fill engine oil up to the level mark "max". Ensure the oil fill plug is tightly screwed into the filler neck during engine operation.
- Check whether sufficient fuel is filled into the tank.

Do not fill the fuel tank to the point of spillage. Instead, top up fuel to the top level mark to allow the fuel to expand.

ADD GASOLINE

WARNING: Be careful when dealing with fuel.

- Fuel is easily inflammable and explosive in certain conditions!
- Never refill close to open fire, inflammable sparks or hot engine parts.
- Do not refill in closed rooms.
- Before each fuel fill, shut off the engine and wait until it has cooled off.
- Do not smoke during filling and keep away from open fire and sparks.
- Do not spill any fuel, use a proper filling device. If fuel is spilled on the ground, ensure the area is absolutely dry and the vapours have evaporated before you start the engine.

Pre-Operation Procedures

NOTE: Before filling fuel tank, remove and discard the debris plug that is inside the tank. Fill fuel tank. Use fresh, clean, regular unleaded gasoline with a minimum of 87 octants. Do not mix oil with gasoline. Purchase fuel in quantities that can be used within 30 days to assure fuel freshness.



WARNING: Experience indicates that alcohol blended fuels (called gasohol or using ethanol or methanol) can attract moisture which leads to separation and formation of acids during storage. Acidic gas can damage the fuel system of an engine while in storage. To avoid engine problems, the fuel system should be emptied before storage of 30 days or longer. Drain the gas tank, start the engine and let it run until the fuel lines and carburetor are empty. Use fresh fuel next season. See storage instructions for additional information. Never use engine or carburetor cleaner products in the fuel tank or permanent damage may occur.



CAUTION: Fill to bottom of gas tank filler neck. Do not overfill. Wipe off any spilled oil or fuel. Do not store, spill or use gasoline near an open flame.

Operation Procedures

Starting the Engine

- Check whether all guards are in proper position.

WARNING: Do not start the engine in closed rooms. Exhaust fumes contain carbon monoxide which acts toxic when inhaled.



- 1 Open the fuel tap and then turn the engine-shut-off switch to position "ON".
- 2 A: Cold engine: Pull the ring "A" out to set the throttle to "CHOKE" position, then push the ring in after engine running.
B: When the engine is warm or in hot weather Move the speed control lever to 1/3 position.
- 3 Pull the starting-rope on handle until you feel the starter clutch engage. Then **pull hard and fast** to start the engine. After the start, let the rope glide back. Do not let it snap.

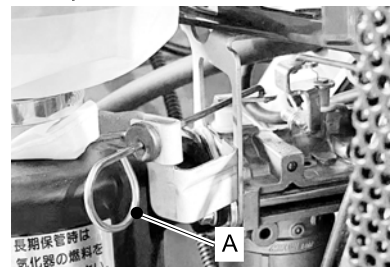

WARNING: In order to start the motor the operator must stand to the right of the machine, must not hold the operating lever on the handlebar and should pull the starting rope out to the right. Keep off the danger zone. Caution with hot engine parts.

The exhaust and other engine parts will become very hot, if the engine runs and immediately after turning off. Hold for sufficient distance from hot surfaces and keep children away from the running engine.

Warming the Engine

- 1 Set the speed control lever to idling position and let the engine run with idling speed for approximately 1/2 minute.

Operation Procedures cont'd ...

2 Move the throttle control lever completely to the STOP position and then switch off the engine-shut-off switch.

WARNING: For shutting off the engine, do not set the control lever to the CHOKE position – risk of fire!

3 Close the fuel tap.

Engine-shut-off switch

In an emergency turn the knob of engine-shut-off switch to position "STOP" to shut off the engine instantly.

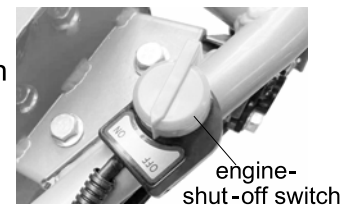

Danger zone

Careful! Dirt and stones may get airborne during mowing. People and animals must keep out of this area. Watch out for vehicles, window panes and other objects to avoid damage.

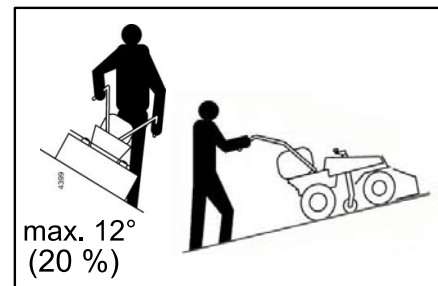
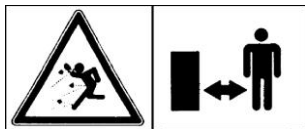



Only work on slopes of up to a max. of 12° .

WARNING: Keep out of the flail mower's Danger zone during starts and operation
Check the immediate surroundings for foreign objects and for children and animals in particular!

Controlling the engine speed

The engine throttle control lever on the right handlebar sets the engine speed steplessly.

The mark "  " means slow, and mark "  " means fast.

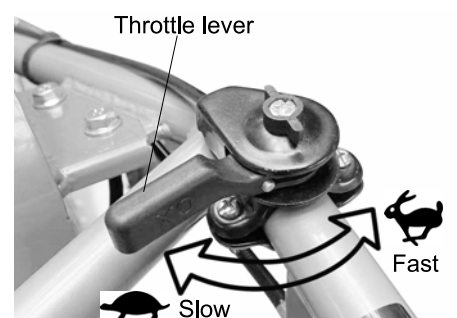

Driving mowing rotor and walking wheels

● The mowing rotor and walking wheel are driven by different belt tensional clutches.

● To turn on the rotor, press down Hold-To-Run lever and keep holding on firstly, and then push rotor clutch lever forward to the end of whole stroke, and then it can be locked automatically.

● To turn on walking wheels, keep holding on Hold-To-Run lever together with left handle, and then push walking clutch lever forward to the end of whole stroke, and then it can be locked automatically.

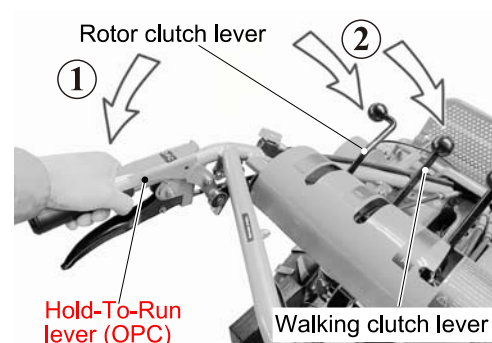

Operation Procedures cont'd ...

- To turn off mowing rotor or walking wheels, release the OPC lever, and then clutch levers will jump back to original position automatically.

Note: Park the flail mower only when all drives are disengaged (see Chapter “Storage”) to avoid clutch problems.

Mowing

- 1 Start the engine as described in “Starting the engine“
 - 2 Wear individual protective ear plugs and solid shoes.
- Make sure the driving speed lever is on min. speed gears position or push the lever forward to the end of stroke.
 - **Depress the Hold-To-Run lever and keep holding it together with handlebar grip with left hand firstly, and then push rotor clutch lever forward to the end of whole stroke until the lever locked.**
 - Push walking clutch lever forward to the end of whole stroke with right hand until the lever locked.
 - Set and ensure the throttle lever to Max. speed.
 - Slowly pull the driving speed lever backwark to desired ground speed with right hand, and then holding on both handlebars to become cutting grass.

WARNING: Shut off the engine and disconnect the spark plug connector, if cleaning is necessary during operation.

Changing the ground speed and braking

The flail mower is equipped with a CVT transmission, and operator can shift gears to choice desired speed to suit different circumstance.

- **Press down the Hold-To-Run lever and keep holding it together with handlebar grip, and then engage rotor clutch and walking clutch.**
- Slowly pull the driving speed lever backward to desired ground speed.
- Move driving speed lever forward for low speed and backward for high speed.
- **Move driving speed lever forward to the end of stroke to stop and brake wheels.**

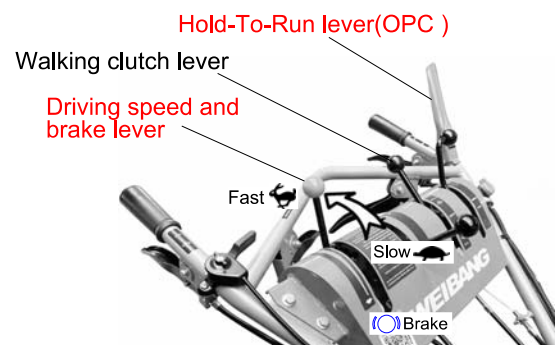

Reverse Driving

- Release the OPC lever to stop the rotor and walking wheels.
- Push the driving speed lever forward to set the walking speed to min.(stop).
- Pull F-R lever out from catch and move backward to set reverse gears.
- **Depress the Hold-To-Run lever and keep holding it together with handlebar grip, and then engage walking clutch.**
- Slowly pull the driving speed lever backward to desired walking speed.
- Take care and always check behind you to ensure safe movement and also ensure no persons, pets, or obstacles are present.

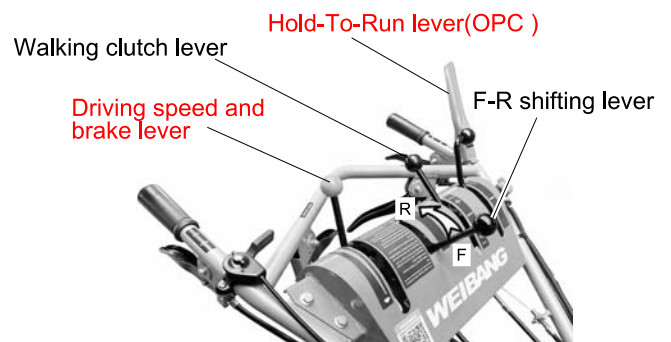

Operation Procedures cont'd ...

Stopping the machine

- Push the driving speed lever forward to set the walking speed to min.(stop).
- Release the OPC lever to reset all control levers and stop the mower.
- Turn the throttle control lever to left to decrease engine speed to min,(idle speed)
- Turn the engine switch off to stop the engine.

Braking and Park braking:

- For brake the machine, release the Hold-To-Run lever, and then clutch levers will jump back to original position automatically. Meanwhile, the drive wheels will stop turning and braked.
- For Park breaking, stop the machine completely and make sure the Driving speed lever has been shift to min. speed position.

Pushing or turning the Machine

- Lift turn clutch levers under both side handlebars and keep holding them to disengage wheels when the engine is shut off, now the machine can be pushed for moving and turning in any direction.
- During operation, lift the left turn clutch lever for left turn or lift the right turn clutch lever for right turn.

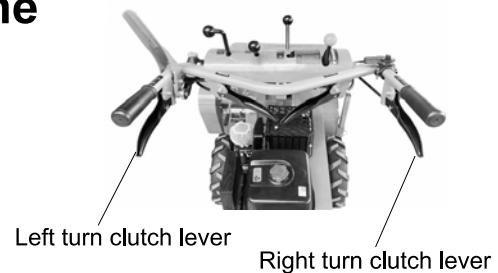

Service And Adjustment

Adjusting the Mowing Height

The mowing height is altered by turning the crank handle.

- Turn the crank handle clockwise to decrease the rotor for low cutting.
- Turn the crank handle anticlockwise to increase the rotor for high cutting.

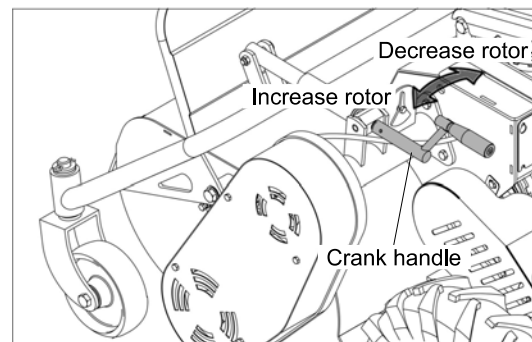
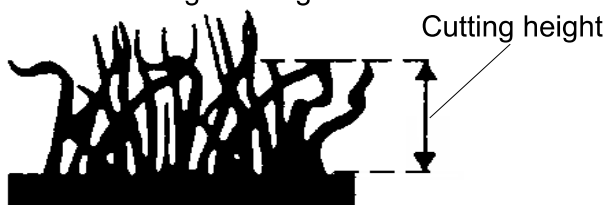

Handlebars

Adjusting handlebars height

- Push the driving speed lever forward to set the walking speed to min.(stop).
- Release the OPC lever to reset all control levers and stop the mower.
- Lift right lever (Handle bar vertical adjustment) under crossbar to set handelbar to desired height and then release the adjustment lever to lock the height.

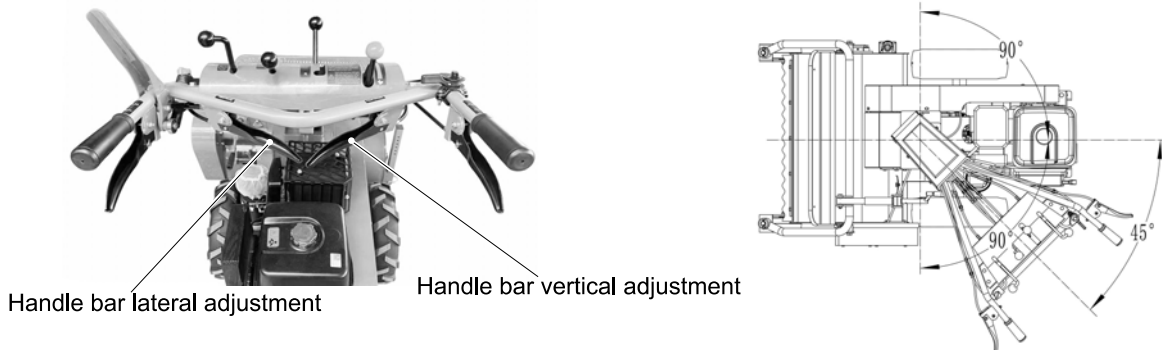

Setting handlebars lateral position.

When mowing weeds under low shrubs and fruit trees, the handlebar can be turned to lateral to avoid inconvenience to the operator.

- Push the driving speed lever forward to set the walking speed to min.(stop).
- Release the OPC lever to reset all control levers and stop the mower.
- Lift left lever (Handle bar lateral adjustment) under crossbar to set handelbar to desired lateral position, then release the adjustment lever to lock the positon.

Engine

Speed Control

Your engine speed has been factory set. Do not attempt to increase engine speed or it may result in personal injury.

Devices for actuating engine speed must be adjusted correctly to start, operate and shut off the engine at correct speed rates. If you believe that the engine is running too fast or too slow, take your sweeper to an authorized service center or local dealer for repair and adjustment.

Carburetor settings

The carburetor has been preset at the factory and adjustment should not be necessary. However, minor adjustment may be required to compensate for differences in fuel, temperature, altitude or load.

The air filter must be assembled to the carburetor when running engine.

Best carburetor adjustment is obtained when fuel tank is 1/4 full. See the Adjustment section of your engine manual for further instruction. **For this adjustment:** Contact to your local dealer

! Apart from adhering to operating instructions for the sweeper, it is also important to observe the following maintenance instructions.

Warning: Only do maintenance work with the engine shut off. To prevent accidental start while working on the rotary brushes or on the engine, always remove the spark plug connector from the spark plug.

Maintenance Procedures

This section encompasses two general types of maintenance: 1. Preventative Maintenance and 2. General Service . The first refers to regularly scheduled routine care of the flail mower, such as cleaning and lubrication. The second provides information on common procedures, such as changing flails, and adjusting the drive belt that are to be performed as needed.

By following the Inspection Schedule below BEFORE and AFTER each use of the flail mower, appropriate actions can be taken to extend the service life of the machine and reduce any costly repairs and unnecessary downtime for the unit.



A. Inspection Schedule

The following list aims offer some basic guidelines to performing a detailed inspection BEFORE and AFTER each use. Certain checks will require some disassembly, i.e. the removal of the drive guard, to perform. Depending on various environ-mental conditions and frequency of use, other inspection points may have to be added for each machine.

Item	Yes	No
Is the engine oil filled to recommended levels? Consult Engine Manufacturer's Manual.		
Is the engine air cleaner properly attached and clean? Consult Engine Manufacturer's Manual.		
Is the clutch cable properly attached? Refer to p.10 "Setting up the Power rake" for details.		
Is the clutch cable worn or visibly damaged? Replace if necessary.		
Is the drive belt tension set properly? Refer to p.16 "Replacing Drive V-Belt and Pulley" for details.		
Does the drive belt show signs of wear and tear? Replace if necessary.		
Are all the flails in good condition? Are any flails worn down to minimum length of 3"/ 7.6 cm? If so, have they been replaced?		
Are the spring clips which secure the flails and rotor shaft in good condition?		
Is the carriage securely fastened and free of all debris? Lingering debris may lead to premature wear on the machine and shorten performance life.		
Are the safety warning labels and other decals clearly identifiable and legible? If not, ensure that fresh decals will be re-applied prior to use for operator safety.		
Is the frame and handle in good condition with no visible damage or rusting? If not, contact your local authorized dealer to replace machine prior to further use.		

B. Preventative Maintenance Procedures

Maintaining a regular cleaning and lubrication schedule as well as taking time to perform preventative maintenance procedures will prolong the service life of the FLAIL MOWER. The following are guidelines to setting up a regular maintenance routine for the flail mower.

1. Cleaning the FLAIL MOWER

- i. After each use, the flail mower, in particular the flails and rotor assembly, should be cleaned and washed of any dirt or debris that may be trapped in the unit.
- ii. When using a power pressure washer to clean the unit, the washer should be approved. **DO NOT USE ANY MACHINE RATED HIGHER THAN 1000 PSI.**
- iii. Beware of damaging any warning decals and labels, as well as the drive belt, bearings and engine. Limit direct spray on these objects to help prevent their wear and tear.

Maintenance Procedures cont'd ...

2. Lubrication Schedule

Regularly scheduled lubrication of the wheels, flails & rotor assembly, and linkage joints in the carriage is essential to smooth performance and extended equipment life. The following schedule is a recommended guide to lubricating your FLAIL MOWER. The schedule should be adjusted for various environmental conditions and frequency of use.



Technician should read and thoroughly understand all manuals pertaining to the machine to be serviced. Do NOT proceed with any service and maintenance activity until ALL questions and concerns have been addressed. Please contact your local authorized dealer for technical support and advice.



ALWAYS consult and verify that all local codes and bylaws are followed before performing any service or maintenance procedures.

Item	Suggested Lubricant	Every 20 hours	Every 60 hours	As required	After each pressure wash	Storage
Engine	Refer to Owner's Manual for Engine			✓		
Cutting height Adjustment Lever	General Purpose Spray Lubricant	✓		✓		
Wheels	Lithium-based Grease		✓	✓	✓	✓
Folding Handle Attachment Kits	General Purpose Spray Lubricant	✓		✓	✓	✓
Flails & Rotor	General Purpose Spray Lubricant			✓	✓	✓
Linkage	General Purpose Spray Lubricant	✓		✓	✓	✓
Zerks	General Purpose Spray Lubricant			✓	✓	✓

C. General Service Procedures

The following are general guidelines for servicing common wear components on the flail mower. ALL MAINTENANCE AND SERVICE WORK MUST BE PERFORMED BY A TRAINED AND EXPERIENCED TECHNICIAN. Ensure that the work area is clean and free of debris prior to starting any maintenance or service work. Small particles may become trapped in key components that may lead to serious damage to the machine and cause severe bodily harm to the operator or technician.

Before performing any service and maintenance procedures, consult these general safety procedures for a safe working environment.

1. Make sure that both the engine and flail mower are cool prior to any service or maintenance work.
2. Verify that work area is clean and free of any debris, tripping or fire hazards, and other potential sources of danger.
3. Always wear proper safety clothing and equipment for the job. These can and should include eye and ear protection, gloves, dust mask and any other items that are appropriate for the job and jobsite requirements.
4. Ensure that the technician has tied back or remove any loose hair, clothing and any other potential hazards and obstructions.
5. Disconnect spark plug.

Maintenance Procedures cont'd ...



Use WEIBANG brand-name parts for compatibility and optimum performance. Use of any other parts prior to consulting with your local authorized dealer will void all warranties expressed herein.

Machine

1. Maintaining Flail Blades

Flails are a normal wear and tear item. There are two procedures that apply to the maintenance of flails:

a. If the striking edge of the flails are dulled by use (see diagram 2), rotate the flail components group align the center line for fresh blades and reassemble them to flail pivot.

b. Replacing the flails when they have reached the wear limits on diagram 2.

Please contact your local dealer for details.

Diag2:

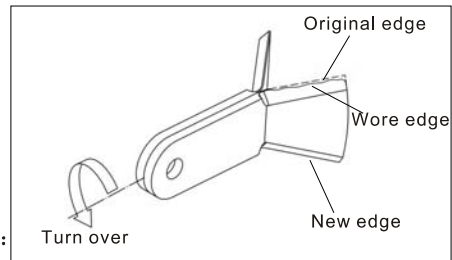

Changing the Blade components

CAUTION: BEFORE YOU CHANGE SETTINGS OR MAINTENANCE TASKS:

1. Release all control levers and switch off the engine to stop the sweeper.
2. Make sure all moving parts have stopped completely.
3. Disconnect cable from the sparkplug and place where it cannot come in contact with plug.
4. Make sure that all the nuts, bolts and screws are tightened and the device in a safe condition.
5. Let the mower to cool before using it in a closed area off.
6. In order to avoid the risk of fire, keep motor housing and ventilation openings free of grass, leaves and oil or fat.
7. Replace worn out or damaged parts for security reasons.

Wear safety gloves to attach/remove the Blade components. Danger of crushing.

- Push the driving speed lever forward to set the walking speed to min.(stop).
- Release the OPC lever to reset all control levers and stop the mower.
- Make sure all moving parts have stopped completely.
- Disconnect cable from the sparkplug and place where it cannot come in contact with plug.

- 1 Press handlebars down to lift machine head up.
- 2 Release a locking pin and draw out the supporting rod to max. extending length and relock it with the help of an assistant.

3 Unscrew fastener to remove over wore balde components.

4 Install original blade components and all fastener. Fasten the lock nut and ensure flail blades can turn freely.

5 Release the locking pin of supporting rod with the help of an assistant, and then low the machine head to contact ground.

6 Insert the locking pin to relock the supporting rod.

- Reconnect cable to the sparkplug.

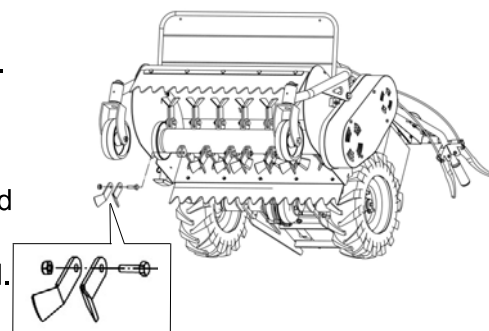
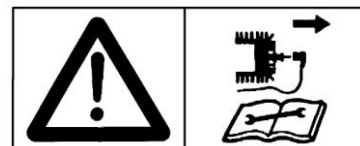

Maintenance Procedures cont'd ...

Transmission box

The transmission box is permanently lubricated.

- Oil change or topping up is not necessary if there are no leakages.
- Have any leakages repaired at once Contact your local dealer

V-Belts

The flail mower is equipped with belts in 4 position as follows:

1. Main belt(2 pcs) which connecting engine and the pivot;
2. Transmission belt(1 pcs) which connecting the pivot and CVT gearbox;
3. Variable transmission belt(2 pcs) on CVT gearbox;
4. Rotor driving belt(2pcs) which connecting the pivot and flail rotor.

Inspect the condition of the V-belts (7 pieces) at least **once per year**.

- Remove the belt cover.
- Replace the V-belts when they are worn.

! Only use original local dealer V-belts.

If it is needed to replace drive V-belt and pulley, please contact your local dealer for details.

Cables

In order to maintain a perfect functioning of the V-belt clutch, the clutch lever must be set to a disengaged condition free from play **i.e. the flail rotor drive must come to a stop.**

If the clutch play needs further adjustment, set it on the cable-setting screw.

User can fine adjust cables connecting the rotor clutch lever and the walking clutch lever.

- Undo locking nut.
- Adjust the setting screw in such a way that the lever is free from play when the unit stop.
- Retighten the locking nut.

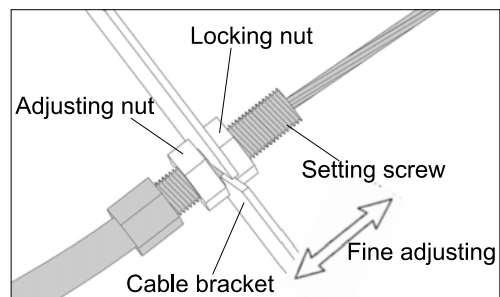

Wheel Shaft

- Apply bio-lubricating grease to the wheel shaft around the hub each time the machine was cleaned with a pressure washer or at least once per year.

Caster Spindle

Apply bio-lubricating grease to the spindle in the area of the swinging hub each time the machine was cleaned with a pressure washer or at least **once per year**.

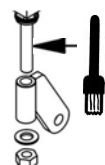

Safety circuit

Check the safety circuit function each time you take up operation and each time you maintain or service the machine.

- 1 When the engine-shut-off switch is at the "OFF" (marking) the engine must come to a stop.
- 2 If the engine-shut-off switch is **not** set to the "ON" position, the engine may not be started!
- 3 Check the electric cable and connections for good condition, replace, if necessary.

Engine

Checking the Engine Oil Level

Before each operation and after 5 operating hours!

- Only with the engine shut off and in horizontal position.
- Clean the oil fill plug and its immediate surrounding
- Remove the oil fill plug, clean the dip-stick with a clean rag and re-insert it all the way – do not screw it in.
- Remove the dip-stick and read the oil level.
- Refill oil, if the oil level is below the lower dipstick mark. Refill engine oil (see “Specifications”) up to upper level mark on dip-stick.

Changing the Engine Oil

For the first time after 5 operating hours, after that after **every 50** operating hours or **annually** (whatever comes first).

Under high loads or at high temperatures, change the oil already after 25 operating hours.

- Remove drain and filler plug.
- Then drain the oil into a suitable container.

(We recommend drain the fuel through the filler neck into a fuel can before draining the oil. Alternatively, use a suction pump to pump the oil from the machine)

- Dispose of the waste oil properly!
- Fill in fresh engine oil. For oil filling capacity and quality see specifications. Fill in the oil using a funnel or similar device if possible. Only change oil while the engine is still warm, but not hot **danger of burns**.

Air Filter

Keep air filter clean and ensure dust thickness not exceed red line.

Clean the air filter insert at **3-month intervals** but not later than operating **25** hours (earlier in very dusty conditions).

To do this, proceed as follows:

- Clean the air filter and its surrounding area.
- Remove the filter cover.
- Remove the paper cartridge.
- Tap the cartridge against a smooth surface or blow compressed air against the inside of the filter. **Never brush the filter because this would press the dirt into the fibres.**
- Replace the filter element if it is extremely dirty.
- Inspect the filter element carefully for holes or other damage and replace it if necessary.
- Replace the filter element
- Re-install filter cover and re-fix it into place.

WARNING! Do not wash the paper element (tap it or blow it out)



Fuel System

- Each time you maintain the machine, check fuel hose, fuel tank, and carburetor for leakages and repair, if necessary. Immediately replace leaking or porous fuel hoses.

Maintenance Procedures cont'd ...

- Replace fuel hoses after every 2 years.
- Clean the fuel tank at 100-hour intervals. Contact to your local dealer for details
- Clean the fuel strainer at 100-hour intervals.

To do this, drain all fuel into a suitable container. Clean the fuel strainer with a cleaning solvent and inspect it for damage. Replace the fuel strainer

Excessive Fuel Supply

After excessive fuel supply to the engine, remove the spark plug, clean and dry it. Then crank the engine with the recoil starter sever times. Afterwards screw the spark plug in and move the speed control lever to "FULL THROTTLE". Then start the engine via the recoil starter.

Spark plug

- After 50 operating hours, clean the spark plug and re-adjust the electrode gap to 0.7–0.8 mm. Only clean the spark plug using a wire brush and wash it out with a commercial cleaning agent.
- Replace the spark plug at 100-hour intervals or when it shows significant wear or if the insulator is damaged.

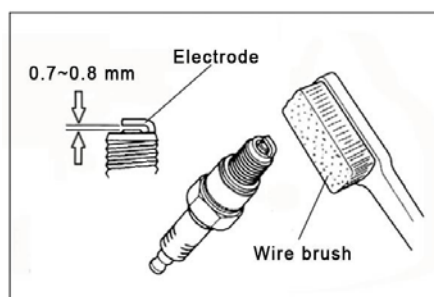

Correct spark plug assembly:

Screw the spark plug into the cylinder head by hand. Then continue with a spark plug wrench. Turn wrench by 90° or at a torque of 20~30 Nm.

Checking the ignition sparks:

Remove the spark-plug, clean it and place it back into the plug connector. Use the lateral electrode to make contact with the engine, pull the starter rope and wait for sparking. If there are no sparks, replace the spark plug.

Governor

For smooth engine performance keep governor linkages, springs and actuating devices clean and free from dust and dirt. Do not bend or twist parts.

Exhaust system

Regularly clean the area around the exhaust from grass, dirt, and inflammable deposits.

– Risk of fire!

Check before each operation.

General

- 1 Watch out for fuel and oil leakage and repair, if necessary.
- 2 Regularly check bolts and nuts for tight fit and retighten, if necessary.
- 3 Slightly grease all gliding and moving parts (e.g. rod that pivots the implement, etc.) with Bio-lubricating grease and Bio-slushing oil (refer to "Lubrication Chart", page37).

Cleaning

On no account spray water into the fan slots in the drive housing!

After each cleaning (washing with water, especially with pressure washer) lubricate all lubrication points, oil and let the sweeper run for a short time to press water out.

Clean the engine only with a cloth. Avoid spraying with air-compressed water jets, as water might leak into ignition and fuel system, causing malfunctions.

Storage

Immediately prepare your flail mower for storage at the end of the season or if the unit will not be used for 30 days or more.

Secure flail mower against unauthorized use - remove spark plug connector.

For longer periods of no operation

- a) Clean thoroughly, remove all dirt, grease, leaves, etc. Store it in a clean, dry area.
1. Clean entire flail mower (See CLEANING in the Customer Responsibilities section of this manual)
 2. Lubricate as shown in the Customer Responsibilities section of this manual.
 3. Be sure that all nuts, bolts, screws, and pins are securely fastened. Inspect moving parts for damage, breakage and wear. Replace if necessary.
 4. Touch up all rusted or chipped paint surfaces; sand lightly before painting.

b) Engine preservation

FUEL SYSTEM

IMPORTANT: IT IS IMPORTANT TO PREVENT GUM DEPOSITS FROM FORMING IN ESSENTIAL SYSTEM PARTS SUCH AS CARBURETOR, FUEL FILTER, FUEL HOSE, OR TANK DURING STORAGE. ALSO, EXPERIENCE INDICATES THAT ALCOHOL BLENDED FUELS (CALLED GASOHOL OR USING ETHANOL OR METHANOL) CAN ATTRACT MOISTURE WHICH LEADS TO SEPARATION AND FORMATION OF ACIDS DURING STORAGE. ACIDIC GAS CAN DAMAGE THE FUEL SYSTEM OF AN ENGINE WHILE IN STORAGE.

- Drain fuel tank completely.
- Start the engine and let it run until the fuel lines and carburetor are empty.
- Never use engine or carburetor cleaner products in the fuel tank or permanent damage may occur.

NOTE: Fuel stabilizer is an acceptable alternative in minimizing the formation of fuel gum deposits during storage. Add stabilizer to gasoline in fuel tank or storage container. Always follow the mix ratio found on stabilizer container. Run engine at least 10 minutes after adding stabilizer to allow the stabilizer to reach the carburetor. Do not drain the gas tank and carburetor if using fuel stabilizer.

Use fresh fuel next season.

- Change the engine oil. Drain oil (with engine warm) and replace with clean engine oil. (See ENGINE in the CUSTOMER RESPONSIBILITIES section of this manual).

CYLINDER

- Fill a tea-spoon (approx. 0.03L) of engine oil into the spark plug opening Slowly crank the engine.
- Re-fit the spark plug and set the piston to compression via the recoil starter (pull the starter grip until resistance is felt) –valves are closed.
- Slowly crank the engine after every 2–3 weeks (spark-plug connector is re moved). Then set the piston to compression again.

DISENGAGING THE DRIVES

Always park the machine with walking clutch lever and rotor clutch lever released to ensure clutches disengaged to avoid clutch problems.

OTHER

- Do not store gasoline from one season to another.
- Replace your gasoline can if your can starts to rust. Rust and /or dirt in your gasoline will cause problems.
- If possible, store your unit indoors and cover it to give protection from dust and dirt.
To avoid severe corrosion:
 - to preserve the machine from atmospheric influences do not park the machine:
 - in humid rooms
 - in rooms where fertilizer is stored
 - in stables or adjacent rooms.
- Cover your unit with a suitable protective cover that does not retain moisture. Do not use plastic. Plastic cannot breathe which allows condensation to form and will cause your unit to rust. Protect the machine with cloth or a similar cover.

! IMPROTANT: NEVER COVER MOWER WHILE ENGINE AND EXHAUST AREAS ARE STILL WARM.

! CAUTION: Never store the flail mower with gasoline in the tank inside a building where fumes may reach an open flame or spark. Allow the engine to cool before storing in any enclosure.

Troubleshooting

Troubleshooting

Problem	Possible cause	Remedy	
Engine can not start	<ul style="list-style-type: none"> - Engine-shut-off switch is "off" - Spark plug connector not connected - Speed control lever not in position CHOKE - Fuel tank empty or poor fuel - Fuel line clogged - Defective spark plug - Engine too much fuel ("flooded engine") - Inleaked air due to loose carburetor and suction line 	Set the switch at "on" position Connect spark plug connector Move speed control lever to position "CHOKE" Fill fresh fuel Clean fuel line Clean, adjust or exchange spark plug Dry and adjust spark plug and start at FULL THROTTLE Tighten attachment bolts	
Misfirings in engine	<ul style="list-style-type: none"> - Engine running in CHOKE range - Loose ignition cable - Clogged fuel line or poor fuel - Vent opening in fuel tank cap clogged - Water or dirt in fuel system - Air filter clogged - Carburetor misadjusted 	Move speed control-lever to operating position, if necessary, adjust speed control. Fit connector tightly on spark plug, fix ignition cable retaining device Clean fuel line, fill fresh fuel Exchange fuel tank cap Drain fuel and fill fresh fuel Clean air filter or exchange Re-adjust carburetor	
Excessive Temperature in engine	<ul style="list-style-type: none"> - Low engine oil level - Air filter clogged - Carburetor misadjusted 	Refill oil immediately Clean air filter Re-adjust carburetor	
Misfiring in engine at high speeds	<ul style="list-style-type: none"> - Short firing intervals - Incorrect idle mix 	Adjust spark plug Adjust carburetor	
Engine frequently stalls in idle	<ul style="list-style-type: none"> - Firing interval too long, defective spark plug - Carburetor misadjusted - Air filter clogged 	Adjust or replace spark plug Re-adjust carburetor Clean air filter	
Engine does not run smoothly	<ul style="list-style-type: none"> - Speed control linkages are clogged or jammed 	Clean speed control linkages	
Engine does not stop when set to stop	<ul style="list-style-type: none"> - Speed and engine stop are not properly adjusted 	Readjust speed control	
Engine output too low	<ul style="list-style-type: none"> - Loose cylinder head or damaged gasket - Poor compression - Air filter clogged 	Tighten cylinder head, exchange gasket Have engine checked Clean the air filter	
Flail rotor does not stop with rotor clutch lever released	<ul style="list-style-type: none"> - Belt clutch problem - Incorrect linkage adjustment of clutch engage lever 	Check belt clutch system and adjust the linkage of clutch engage lever	

Troubleshooting cont'd ...

Wheel drive does not stop with walking clutch lever released	<ul style="list-style-type: none"> - Belt clutch problem - Incorrect linkage adjustment of clutch engage lever 	Check belt clutch system and adjust the linkage of clutch engage lever	
Excessive vibration	<ul style="list-style-type: none"> - Attachment bolts loosened - Loose tensioning rod on rotary 	Tighten attachment bolts Immediately turn off engine! Check tensioning rod and all bolts and nuts for tightness, exchange damaged parts	
* = For this purpose contact your local dealer.			

Inspection and Maintenance Chart

	P	A	After operating hours						min. every 3 months	min. yearly	B		
			5	8	25	50	100	250					
Check free play of all levers		K											
Check air filter		K											
Check engine oil level, refill , if necessary	1	K	K										
Clean exhaust			K										
First engine oil change	1												
subsequent oil changes	1		W			W							
Clean engine, check bolts and nuts					K								
Check wear of rotary brushes earlier if required					K								
Clean air filter insert					W				W				
Replace air filter insert, earlier, if required						W							
Clean spark plug, adjust gap						W							
Replace spark plug							K						
Clean guide plates, cooling fins, earlier, if required							W						
Clean fuel tank							W						
Clean fuel strainer							W						
Lubricate all gliding parts	3										K	K	
Grease wheel shaft	2										K	K	
Grease adjusting spindle											K	K	

Troubleshooting cont'd ...

	P	A	After operating hours						min. every 3 months	min. yearly	B		
			5	8	25	50	100	250					
Check transmission for any areas of leakage											W		
Check V-belts											K		
Replace fuel hoses											W		

A = Each time before you take up operation

B = After each cleaning

K = Checks and maintenance to be executed by operator

W = Maintenance to be executed by professional workshop

P = Item no. in lubrication chart

* = After 2 years

Packing List

NAME	QTY.	REMARK
Flail Mower	1	
ENGINE OPERATOR'S MANUAL	1	
Grass Land Mower OPERATOR'S MANUAL	1	

Record of maintenance/service works

Date	Content	Maintenance Man	Remark

WEIBANG Warranty Statement

WEIBANG GARDEN MACHINE COMPANY LIMITED guarantees all WEIBANG Flail mower to be free from any manufacturer's defects in material and workmanship for a period of 1 year from the date of purchase. This warranty is exclusive of the engine (please consult the accompanying engine manual with your unit for details), and any normal wear and tear and/or consumable parts, such as, but not limited to flails, spacers, clutch, clutch lining, drive belt, and throttle cable. All normal wear and tear and/or consumable parts are protected from manufacturer's defects in material and workmanship for a period of thirty (30) days from the date of purchase.

Weibang Warranty Summary

1. WEIBANG Professional Flail mower Unit
2. Belt and tire
3. WEIBANG normal wear and tear parts or consumable parts
4. Engine

Protection

1year parts and labour
90 days parts and labour

30 days parts and labour

Consult with engine manufacturer

To make a warranty claim within this time period, please contact WEIBANG'S local dealer or WEIBANG's exclusive national distributor, who will advise the validity and claim procedure. Once the claim has been accepted, if it is needed, the unit and/or parts should be shipped to the specified Authorized Service Centre at the customer's expense. Be sure to securely pack the unit and parts in a strong container. Damage in transit is not covered by this warranty.

Warranties expressed in this document are void if repairs are attempted by anyone other than an Authorized Service Centre or WEIBANG's exclusive national distributor, or if the unit has been modified from original factory design in any way. This warranty is expressly conditional upon the customer's compliance with all precautions and instructions contained in this manual and excludes any claims made as a result of abuse, neglect, accident, normal wear and tear and misuse. This warranty is nontransferable.

Yangzhou Weibang Garden Machine Company Limited
Hanjiang Industrial Park
Yangzhou, Jiangsu, P.R. CHINA

Tel: +86-514-87849959, +86-514-87849975 Fax: +86-514-87849938

Email questions and comments to:

Sale@weibang.com

Visit our website:

www.weibang.com

WEIBANG WARRANTY REGISTRATION

Customer

Congratulations for choosing an WEIBANG product to meet all your tough jobsite needs! Please file your original bill of purchase for this unit in a safe place. For warranty service of your WEIBANG product, you will need to provide a copy of this document to confirm your warranty status.

Product registration is a key step toward enjoying your new WEIBANG product! While registration is not necessary to enjoy our manufacturer's warranty, there are many benefits to participating in this program. Registration helps to facilitate warranty service, and notify you of any updates, changes, and service advisories on your product. Complete this Warranty Registration Card and fax it to _____ or mail it to the address on the back of this card within 14 days.

Data Protection: your data will be held and used by WEIBANG and their authorized dealers for warranty administration and marketing purposes only. WEIBANG will not forward this data to third parties.

If you do not wish to receive marketing information please tick box.

Warranty Registration Information			
<i>A. Ownership Information</i>			
Owner's Name:			
Owner's Address:			
Post code:		Country:	
<i>B. Machine Information</i>			
Date of purchased:			
Machine Model:			
Machine Serial No:			
<i>C. Product Information Update</i>			
Can we contact you with any product-related news?			
Who should we contact?			
Contact Telephone:			
Contact Fax:			
Contact E-Mail:			
What is the preferred contact method?			
<i>D. Signature</i>			
Dealer name/address		Signature	
Customers: My signature hereby confirms that I have received the operating instruction intended for the device, instructions and the device free of obvious defects.		Signature	

EC DECLARATION OF CONFORMITY

Business name of the manufacturer: **Yangzhou Weibang Garden Machine Company Limited**

full address of the manufacturer: **Hanjiang Industrial Park, Yangzhou City,**

Jiangsu Province 225127, P. R. China

name and address of the person (established in the Community) compiled the technical file:

Cristoph Meyer, Bochstraße 1, D23569 Lubeck ,Germany

We declaring that the machinery

product name: **Flail mower**

commercial name: **Flail mower / High grass mulching mower**

function: **Service for agriculture and forestry**

model:

WBGT6813 WBGT8013

type: **gasoline powered**

serial no.:

fulfils all the relevant provisions of Directives:

2006/42/EC, 2014/30/EU

and tested in accordance with below standards:

EN 12733

place and date of the declaration: **Jiangsu 2022-12-20**

signature of the person:

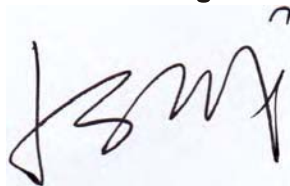

Sucheng Ju (General Manager)

WEIBANG WARRANTY REGISTRATION

Dealer keep

Congratulations for choosing an WEIBANG product to meet all your tough jobsite needs! Please file your original bill of purchase for this unit in a safe place. For warranty service of your WEIBANG product, you will need to provide a copy of this document to confirm your warranty status.

Product registration is a key step toward enjoying your new WEIBANG product! While registration is not necessary to enjoy our manufacturer's warranty, there are many benefits to participating in this program. Registration helps to facilitate warranty service, and notify you of any updates, changes, and service advisories on your product. Complete this Warranty Registration Card and fax it to _____ or mail it to the address on the back of this card within 14 days.

Data Protection: your data will be held and used by WEIBANG and their authorized dealers for warranty administration and marketing purposes only. WEIBANG will not forward this data to third parties.

If you do not wish to receive marketing information please tick box.

Warranty Registration Information			
<i>A. Ownership Information</i>			
Owner's Name:			
Owner's Address:			
Post code:		Country:	
<i>B. Machine Information</i>			
Date of purchased:			
Machine Model:			
Machine Serial No:			
<i>C. Product Information Update</i>			
Can we contact you with any product-related news?			
Who should we contact?			
Contact Telephone:			
Contact Fax:			
Contact E-Mail:			
What is the preferred contact method?			
<i>D. Signature</i>			
Dealer name/address		Signature	
Customers: My signature hereby confirms that I have received the operating instruction intended for the device, instructions and the device free of obvious defects.		Signature	